

SECTION A-A

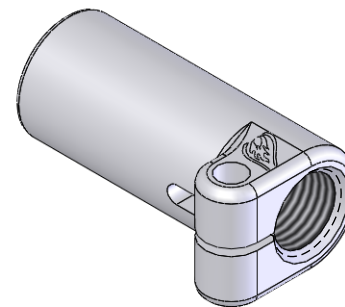

Specialty Products Company
 Longmont, Colorado USA • www.specprod.com

LINEAR mm[in] ANGLE (deg.)
 None±1.00 [X ±.040"] None± 2.0°
 .X ±0.50 [XX ±.020"] .X ± 1.0°
 .XX ±0.25 [XXX±.010"] .XX ± 0.5°
 CONFORMS TO
 ASME Y14.5

15120

MATERIAL: 4140 PER SAE ASTM A 331
 FINISH: None